

Product Name: i5

General information

- This luminaire must be installed in accordance with the latest edition of the IET Wiring Regulations and local Building Regulation by a qualified competent person.
- The mains power supply must be turned off before inspection, installation or removal of the luminaire, ensuring that the supply is locked off to prevent inadvertently switching the supply on.
- It is the installer's responsibility to ensure that the installation is suitable for the total load of the luminaire(s). The supply cable fuses/circuit breakers must be correctly rated for the electrical load and taking into account for any transient inrush currents that may occur.
- It is the installer's responsibility to ensure that the environmental operating and storage conditions are complied with and that any fire risks are considered.
- Do not perform insulation strength or insulation resistance tests on the installation with the luminaire(s) connected, this can damage the luminaires and give erroneous readings.
- Do not loop-in supply cables at the luminaire supply terminals unless there is provision for 2-way connection at the terminals.
- The light source contained in this luminaire must only be replaced by TamLite Lighting or an appointed service agent.
- Emergency lighting luminaires must be installed and maintained in accordance with the emergency lighting standard BS 5266-1.
- To ensure that the product warranty remains valid, the luminaire must be installed and maintained in accordance with these installation instructions and the product must not be modified in any way.



Luminaires marked with this symbol must not be covered with thermally insulating material.



This symbol on covers over light sources indicates dangerous live parts do not operate the luminaire with this cover removed.

Dimensions

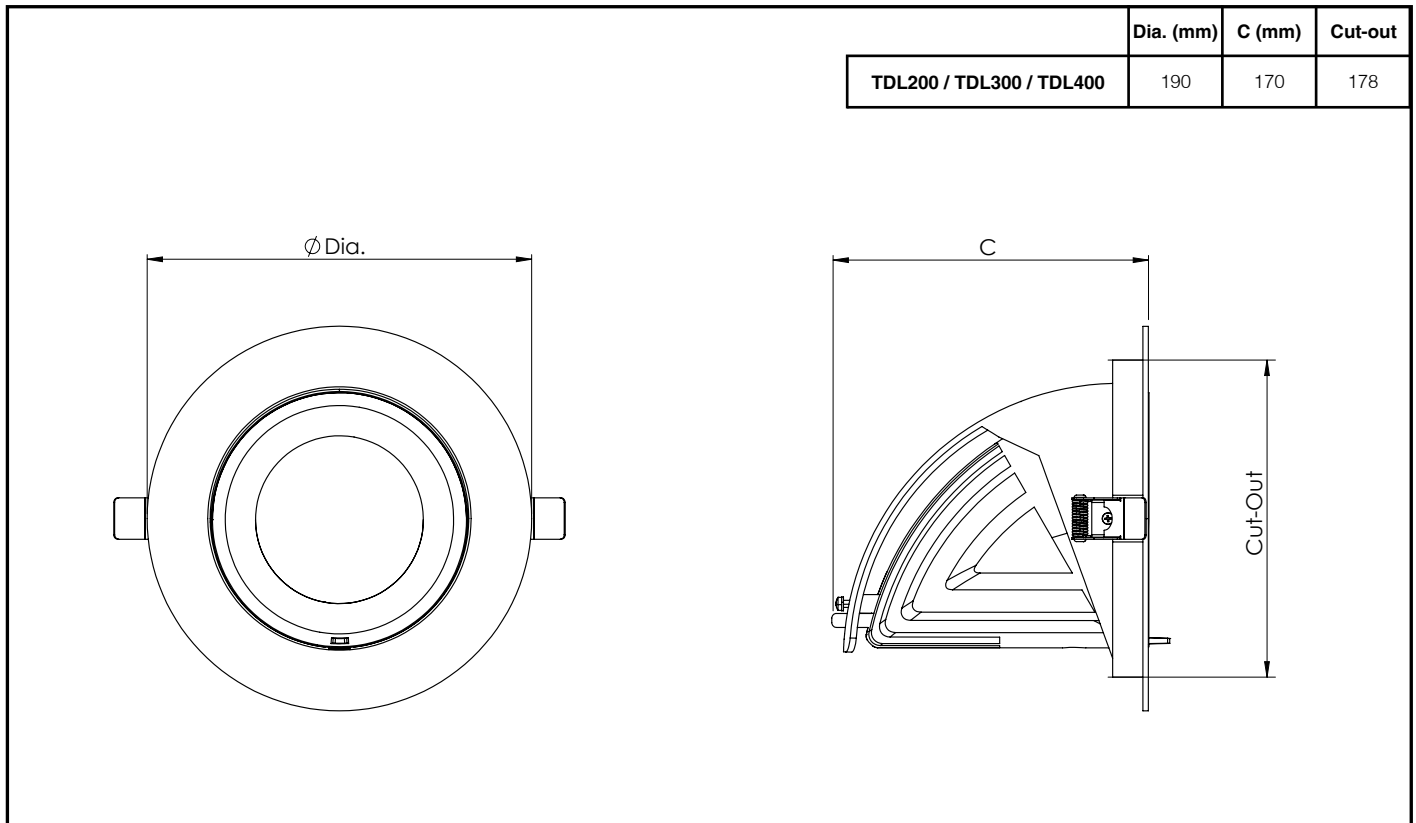

Page 1 of 2

Tamlite Technical
Stafford Park 12,
Telford, Shropshire,
TF3 3BJ

+44(0)1952 292441
technical@tam-lite.co.uk
Document No: V1

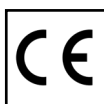

220-240V
50/60Hz

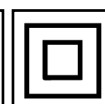

IP20

IK04

ta
0°C to 25°C
5°C to 25°C
for M3 variants

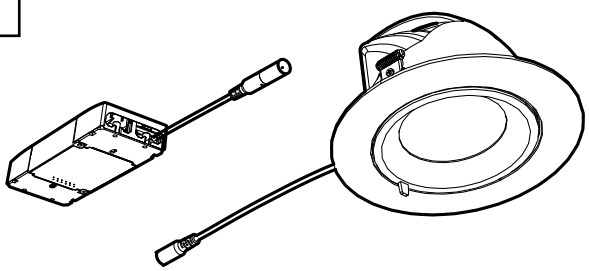
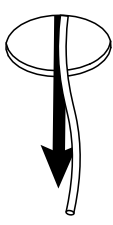
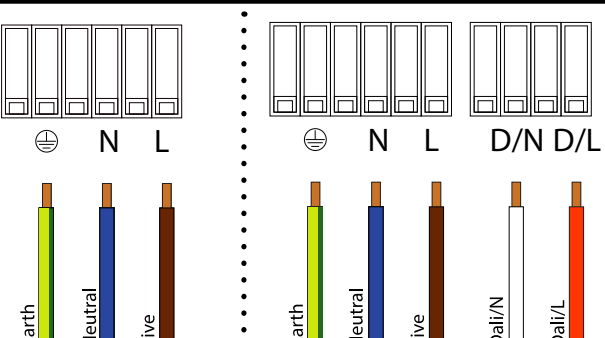
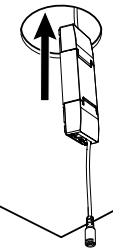
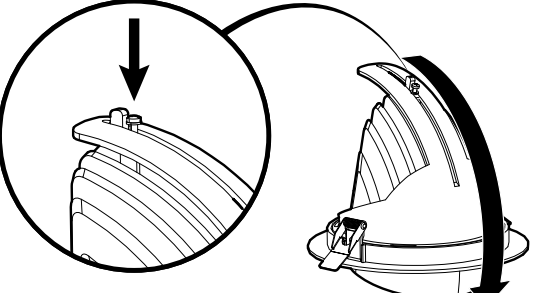
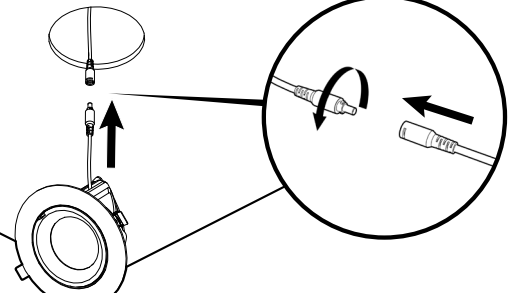
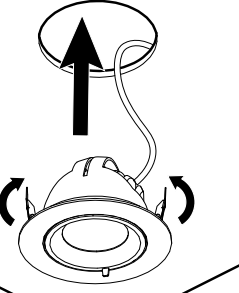
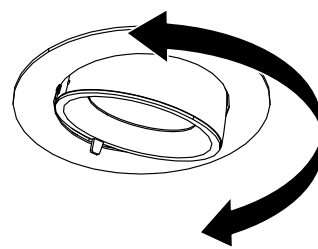

Product Name: i5

<div style="border: 1px solid black; padding: 5px;"> <p>1</p>  <p>Remove the product from its packaging.</p> </div>	<div style="border: 1px solid black; padding: 5px;"> <p>2</p>  <p>Bring incoming supply cable to the intended luminaire position.</p> </div>
<div style="border: 1px solid black; padding: 5px;"> <p>3</p>  <p>Terminate supply cable according to the markings on the LED driver.</p> </div>	<div style="border: 1px solid black; padding: 5px;"> <p>4</p>  <p>Feed the LED driver in to the ceiling void.</p> </div>
<div style="border: 1px solid black; padding: 5px;"> <p>5</p>  <p>Adjust the luminaire tilt angle.</p> </div>	<div style="border: 1px solid black; padding: 5px;"> <p>6</p>  <p>Connect the luminaire to the LED driver connector.</p> </div>
<div style="border: 1px solid black; padding: 5px;"> <p>7</p>  <p>Fold the recess arms up and install the unit.</p> </div>	<div style="border: 1px solid black; padding: 5px;"> <p>8</p>  <p>Adjust the position of the luminaire as necessary.</p> </div>

Page 2 of 2

Tamlite Technical
 Stafford Park 12,
 Telford, Shropshire,
 TF3 3BJ

+44(0)1952 292441
 technical@tamllite.co.uk
 Document No: V1

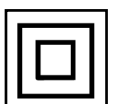
			220-240V 50/60Hz		IP20	IK04	ta 0°C to 25°C 5°C to 25°C for M3 variants
---	---	---	---------------------	---	------	------	---