



Product Name: 12V LED TAPE IP65

General information

- This luminaire must be installed in accordance with the latest edition of the IET Wiring Regulations and local Building Regulation by a qualified competent person.
- The mains power supply must be turned off before inspection, installation or removal of the luminaire, ensuring that the supply is locked off to prevent inadvertently switching the supply on.
- It is the installer's responsibility to ensure that the installation is suitable for the total load of the luminaire(s). The supply cable fuses/circuit breakers must be correctly rated for the electrical load and taking into account for any transient inrush currents that may occur.
- It is the installer's responsibility to ensure that the environmental operating and storage conditions are complied with and that any fire risks are considered.
- Do not perform insulation strength or insulation resistance tests on the installation with the luminaire(s) connected, this can damage the luminaires and give erroneous readings.
- Do not loop-in supply cables at the luminaire supply terminals unless there is provision for 2-way connection at the terminals.
- The light source contained in this luminaire must only be replaced by TamLite Lighting or an appointed service agent.
- Emergency lighting luminaires must be installed and maintained in accordance with the emergency lighting standard BS 5266-1.
- To ensure that the product warranty remains valid, the luminaire must be installed and maintained in accordance with these installation instructions and the product must not be modified in any way.

-  Luminaires marked with this symbol must not be covered with thermally insulating material.
-  This symbol on covers over light sources indicates dangerous live parts do not operate the luminaire with this cover removed.

Dimensions

	A (mm)	B (mm)	C (mm)
FXX121NW / FXX121WW	1000	10	2000
FXX122NW / FXX122WW	2000	10	2000
FXX123NW / FXX123WW	3000	10	2000
FXX124NW / FXX124WW	4000	10	2000

	A (mm)	B (mm)	C (mm)
FXX125NW / FXX125WW	5000	10	2000
FXX126NW / FXX126WW	6000	10	2000
FXX127NW / FXX127WW	7000	10	2000
FXX128NW / FXX128WW	8000	10	2000

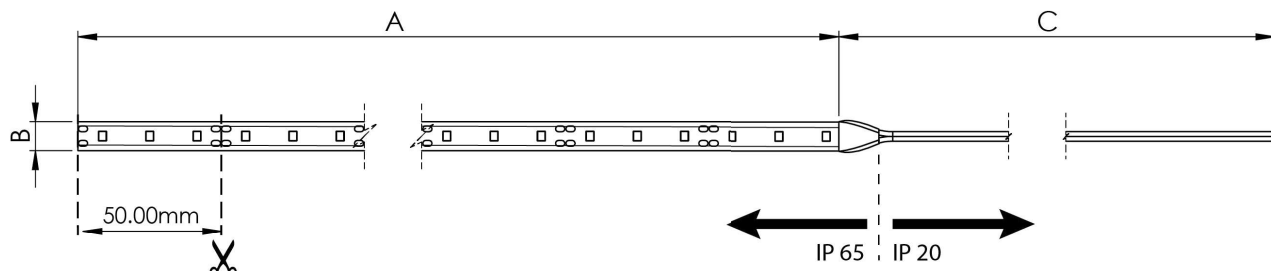

Warning!
This LED tape **MUST** be connected to a suitable driver.
Please refer to the driver's instructions.

Page 1 of 2

Tamlite Technical
Stafford Park 12,
Telford, Shropshire,
TF3 3BJ

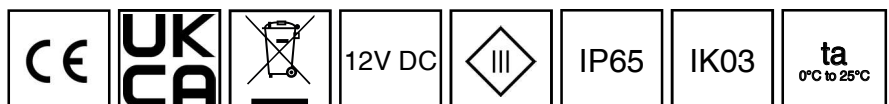

+44(0)1952 292441
technical@tam-lite.co.uk
Document No: V1



INSTALLATION & OPERATING INSTRUCTIONS

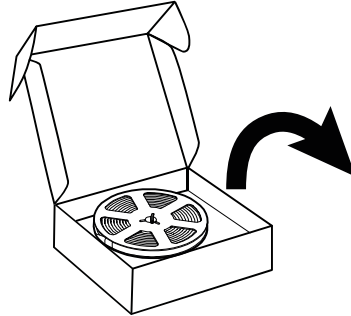
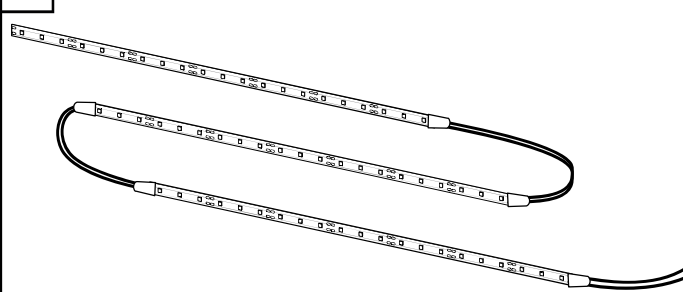
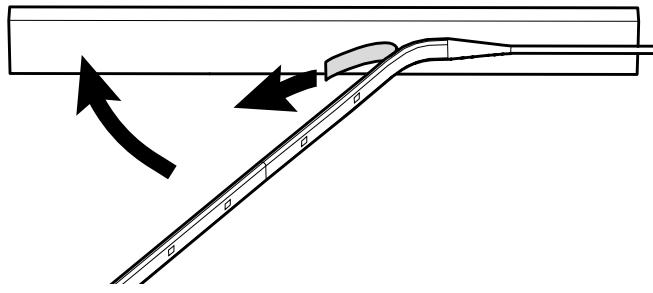
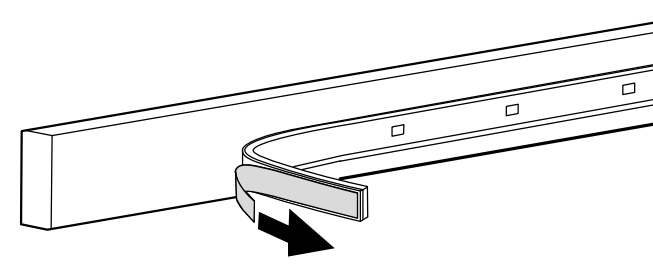

Product Name: 12V LED TAPE IP65

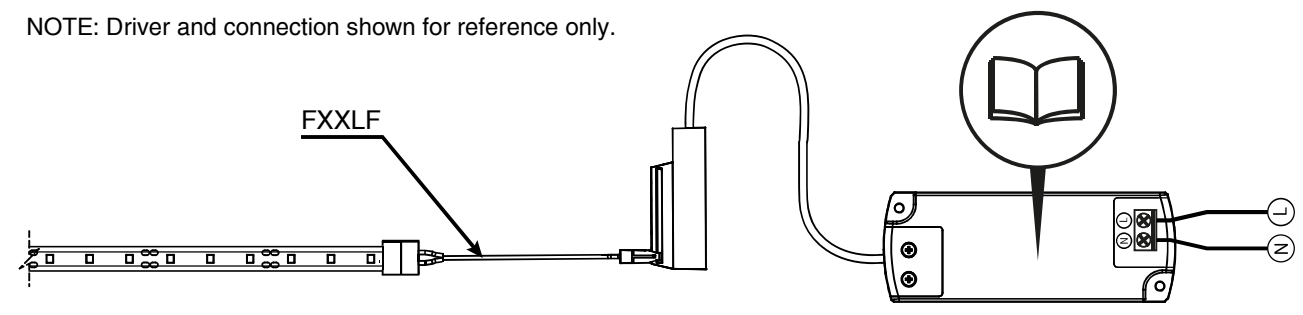
<p>1</p>  <p>Remove the product from the packaging.</p>	<p>2</p>  <p>Prepare LED tape for install.</p>
<p>3</p>  <p>Remove backing paper and attach LED tape to a clean, flat and dry surface.</p>	<p>4</p>  <p>Continue to install the tape, ensuring good contact with the mounting surface.</p>
<p>5a</p> <p>NOTE: Driver shown for reference only.</p>  <p>Connect to an appropriate power supply with reference to the instruction sheet supplied with the power supply.</p>	
<p>5b</p> <p>NOTE: Driver and connection shown for reference only.</p>  <p>If applicable, connect to an appropriate power supply via an AMP connector and FXXLF connector.</p>	

Page 2 of 2

Tamlite Technical
Stafford Park 12,
Telford, Shropshire,
TF3 3BJ

+44(0)1952 292441
technical@tamllite.co.uk
Document No: V1

