



Product Name: CITY PTL

General information

- This luminaire must be installed in accordance with the latest edition of the IET Wiring Regulations and local Building Regulation by a qualified competent person.
- The mains power supply must be turned off before inspection, installation or removal of the luminaire, ensuring that the supply is locked off to prevent inadvertently switching the supply on.
- It is the installer's responsibility to ensure that the installation is suitable for the total load of the luminaire(s). The supply cable fuses/circuit breakers must be correctly rated for the electrical load and taking into account for any transient inrush currents that may occur.
- It is the installer's responsibility to ensure that the environmental operating and storage conditions are complied with and that any fire risks are considered.
- Do not perform insulation strength or insulation resistance tests on the installation with the luminaire(s) connected, this can damage the luminaires and give erroneous readings.
- Do not loop-in supply cables at the luminaire supply terminals unless there is provision for 2-way connection at the terminals.
- The light source contained in this luminaire must only be replaced by TamLite Lighting or an appointed service agent.
- Emergency lighting luminaires must be installed and maintained in accordance with the emergency lighting standard BS 5266-1.
- To ensure that the product warranty remains valid, the luminaire must be installed and maintained in accordance with these installation instructions and the product must not be modified in any way.

-  Luminaires marked with this symbol must not be covered with thermally insulating material.
-  This symbol on covers over light sources indicates dangerous live parts do not operate the luminaire with this cover removed.

Dimensions

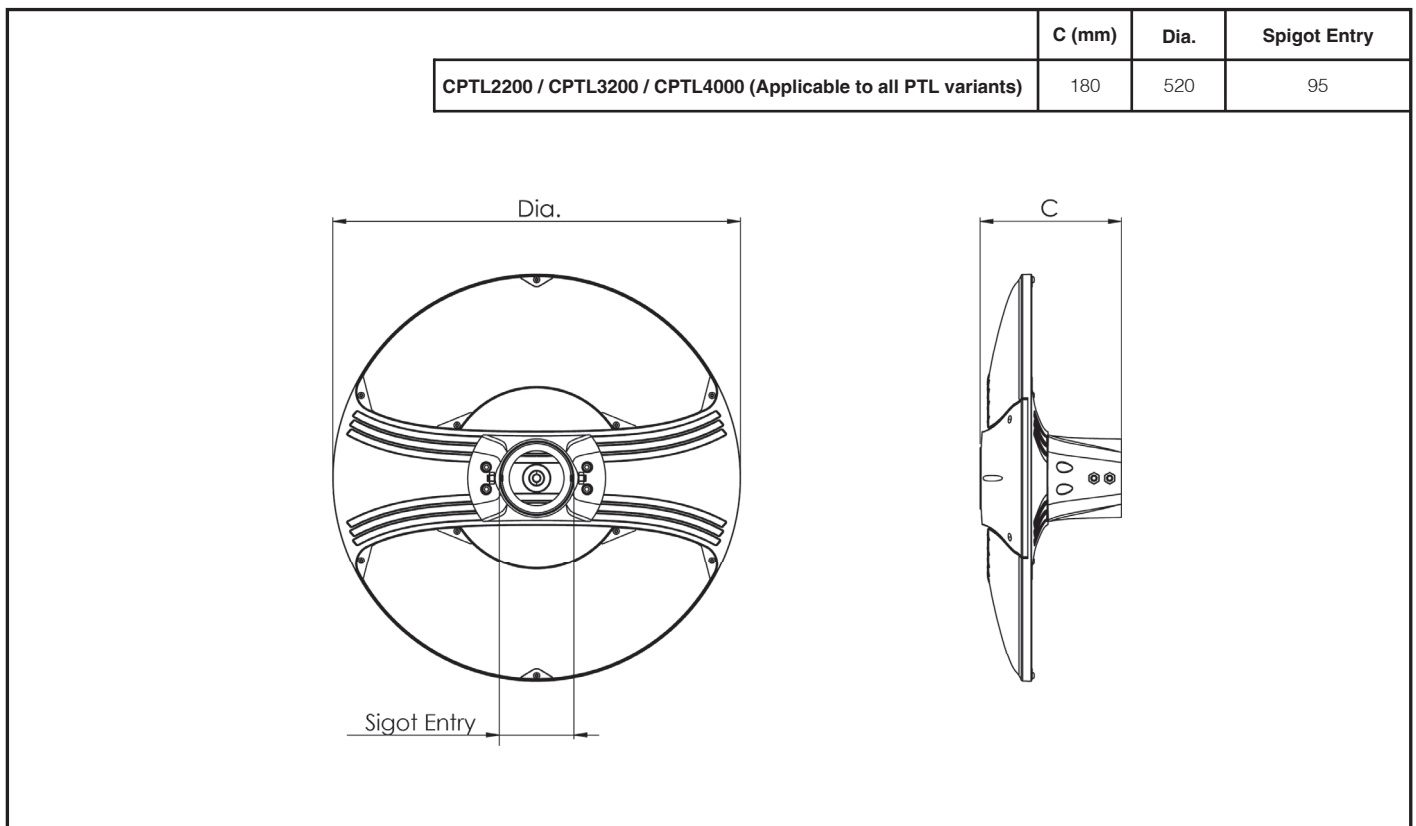

Page 1 of 2

Tamlite Technical
Stafford Park 12,
Telford, Shropshire,
TF3 3BJ

+44(0)1952 292441
technical@tam-lite.co.uk
Document No: V2

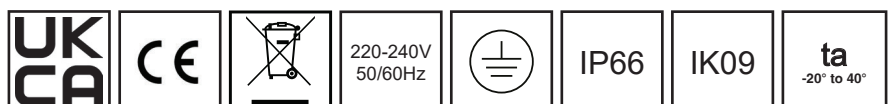

Product Name: CITY PTL

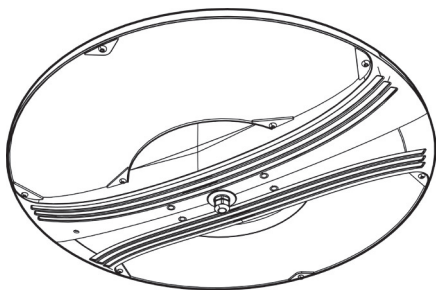
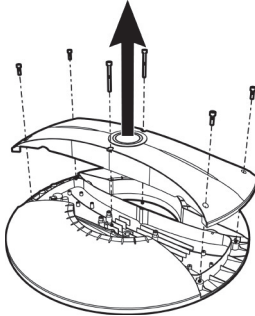
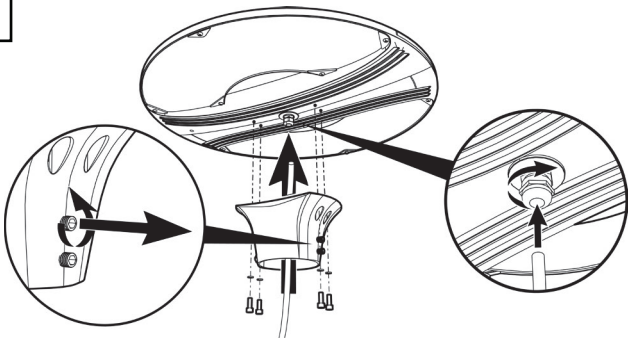
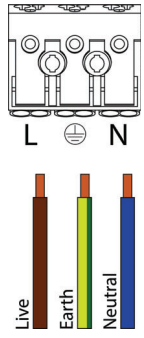
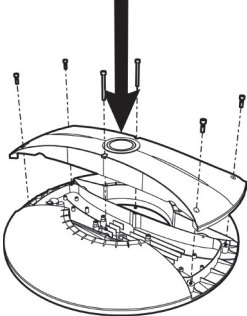
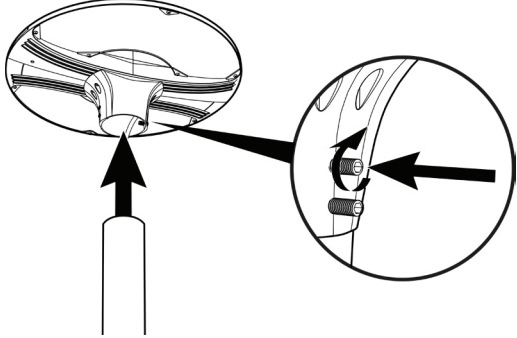
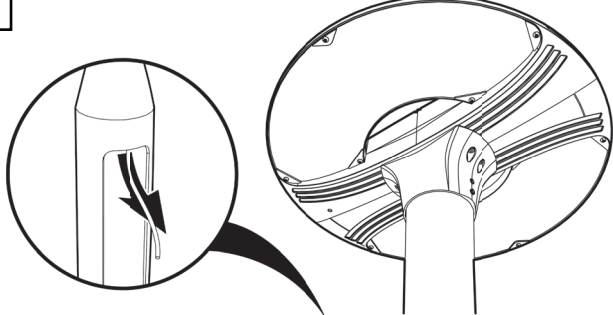
| | |
|---|--|
| <p>1</p>  <p>Remove the product from its packaging.</p> | <p>2</p>  <p>Remove the six screws to release the cover plate</p> |
| <p>3</p>  <p>Feed the supply cable through the cable entry and tighten the gland.</p> | <p>4</p>  <p>Connect supply cable as shown.</p> |
| <p>5</p>  <p>Replace the cover plate and secure with the six screws.</p> | <p>6</p>  <p>Install the luminaire to the lighting column and secure with six grub screws.</p> |
| <p>7</p>  <p>Connect to mains supply as appropriate.</p> | |

Page 2 of 2

Tamlite Technical
Stafford Park 12,
Telford, Shropshire,
TF3 3BJ

+44(0)1952 292441
technical@tamllite.co.uk
Document No: V2

